

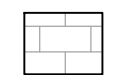

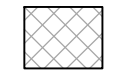



**LEGEND:**

-  PERMEABLE PAVEMENT
-  ASPHALT FOR VEHICULAR LOADING
-  ASPHALT FOR ATHLETIC RUNWAY TRACK
-  VEHICULAR CONCRETE PAVERS ON STRUCTURE
-  CONCRETE
-  FLEXI-PAVE FLEXIBLE POROUS PAVEMENT
-  STONE DUST BIKE TRAIL

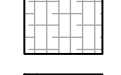

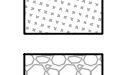
**CAUTION!!**  
 THE LOCATIONS OF ALL EXISTING UNDERGROUND UTILITIES SHOWN ON THIS PLAN ARE BASED UPON ABOVE GROUND EVIDENCE (INCLUDING, BUT NOT LIMITED TO, MANHOLES, INLETS, VALVES, AND MARKS MADE UPON THE GROUND BY OTHERS) AND ARE SPECULATIVE IN NATURE. THERE MAY ALSO BE OTHER EXISTING UNDERGROUND UTILITIES FOR WHICH THERE IS NO ABOVE GROUND EVIDENCE OR FOR WHICH NO ABOVE GROUND EVIDENCE WAS OBSERVED. THE EXACT LOCATIONS OF SAID EXISTING UNDERGROUND UTILITIES SHALL BE VERIFIED BY THE CONTRACTOR PRIOR TO ANY AND ALL CONSTRUCTION.

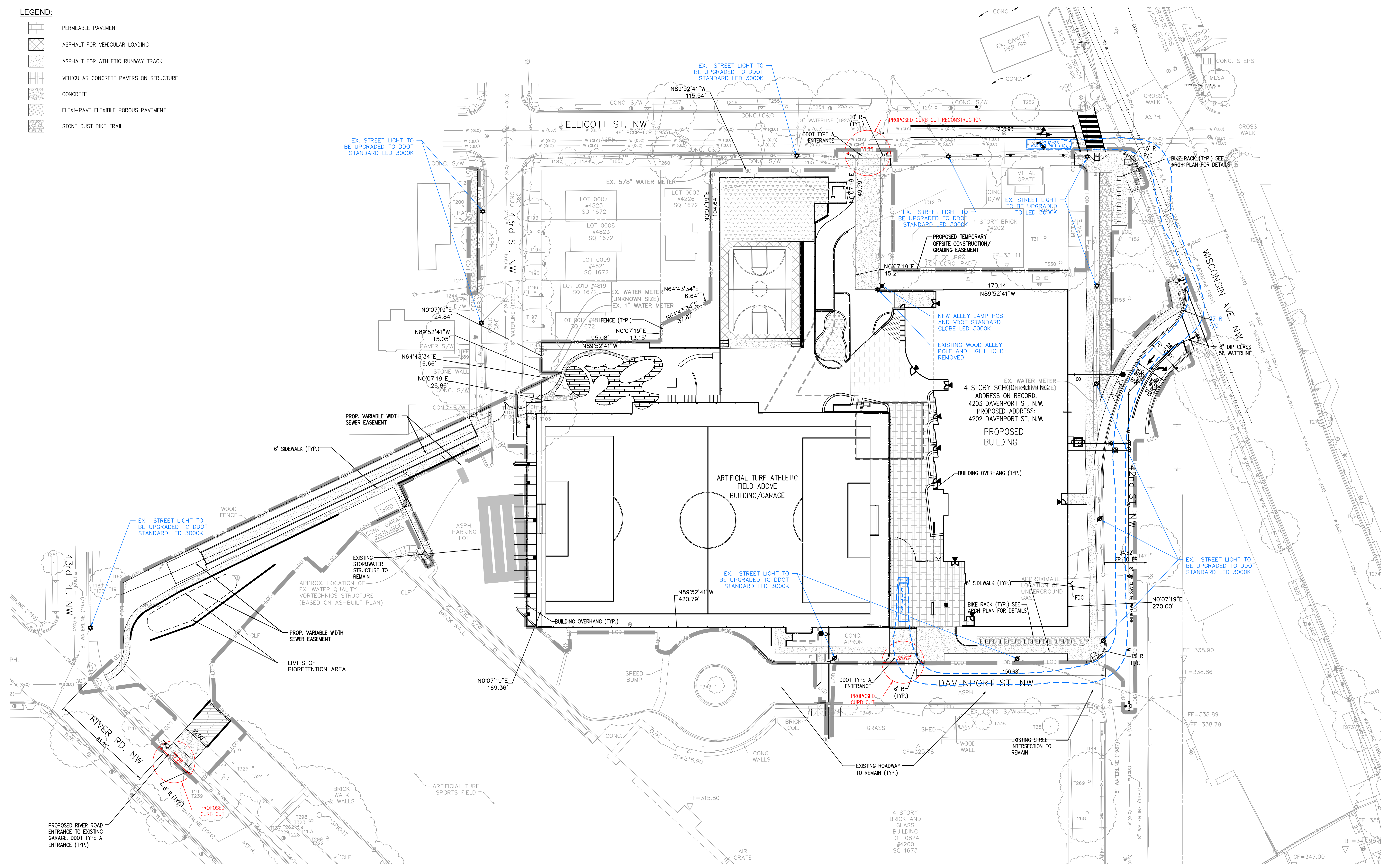
**MISS UTILITY**  
 CALL DC ONE CALL "DOC" AT 1-800-257-7777 48 HOURS PRIOR TO THE START OF WORK. THE EXCAVATOR MUST NOTIFY ALL PUBLIC UTILITY COMPANIES WITH UNDER GROUND FACILITIES IN THE AREA OF PROPOSED EXCAVATION AND HAVE THOSE FACILITIES LOCATED BY THE UTILITY COMPANIES PRIOR TO COMMENCING EXCAVATION. THE EXCAVATOR IS RESPONSIBLE FOR COMPLIANCE WITH REQUIREMENTS OF THE DISTRICT OF COLUMBIA CODES AND REGULATIONS.

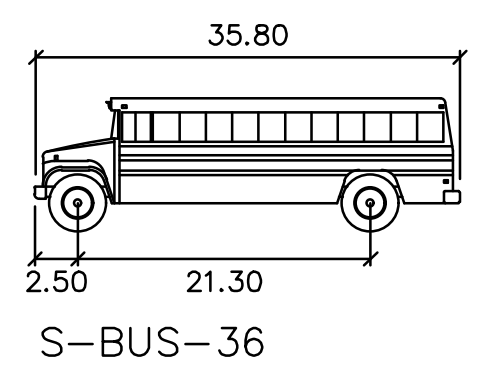

PLAN STATUS	
DATE	DESCRIPTION
DESIGN	DRAWN
SCALE	CHKD
JOB No.	
DATE : JANUARY 17, 2018	
FILE No.	
SHEET 1 of 1	